

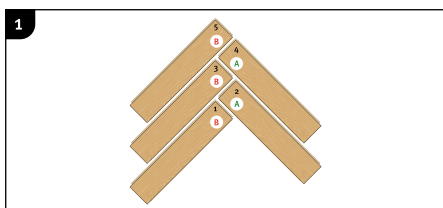

Important information

- The flooring must be acclimated a minimum of 24 to 48 hours prior to installation in the room where the installation will take place
- In larger rooms the flooring must be installed in smaller sections with expansion joints.
- The distance to walls and other permanent pieces of construction elements (such as pillars and kitchen islands) should be approximately 5 mm
- Never install very heavy pieces of furniture such as kitchen islands/cabinets on top of the flooring
- The indoor climate should have a temperature between 15-23 °C and relative air humidity between 30-60%.
- Always follow the floor manufacturers requirements and specifications regarding subfloor preparation.

1. Build starting triangles



Take B-strips and A-strips and position them as shown above.

Note! The number of strips varies depending on the width of the strips used.

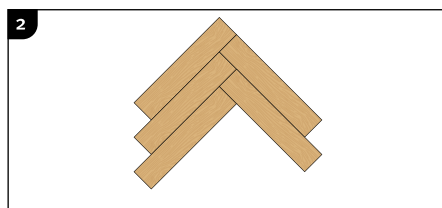

Install the strips precisely and in the order indicated by the numbers on the strips. Carefully check the joints between the strips after every strip that is added.

Note! No protruding edge may be felt!

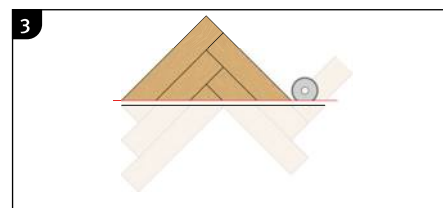

Cut the triangle according to the indicated red line. Depending on the kind of saw you use, it may be useful to dismantle the triangle before sawing.

Note! The excess (below the line) is to be saved for last row installation.

2. Measuring the room

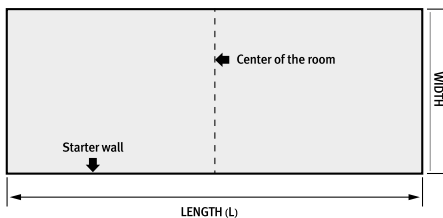

Define the wall from where you intend to start the installation. Mark out the center of the room.

3. Calculating the number of triangles

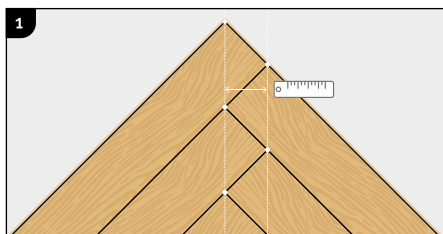

Measure the distance between the two straight lines, originating from the corners of the strips.

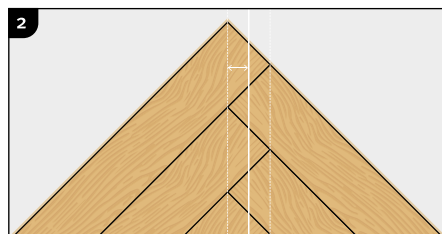

Devide this number by two, and get the **X measurement**.

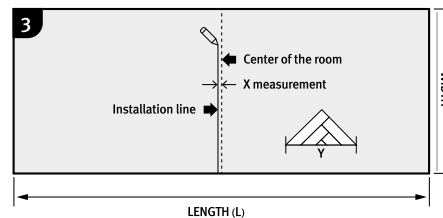

Drawing the installation line

Start from the center of the room. Parallel offset the line using the **X measurement** as distance.

$$\frac{L + X}{Y} = \text{Quantity}$$

Calculate the number of needed starting triangles with the formula to the left.

Note! Round up to the next full number.



Välinge

4. Start installation

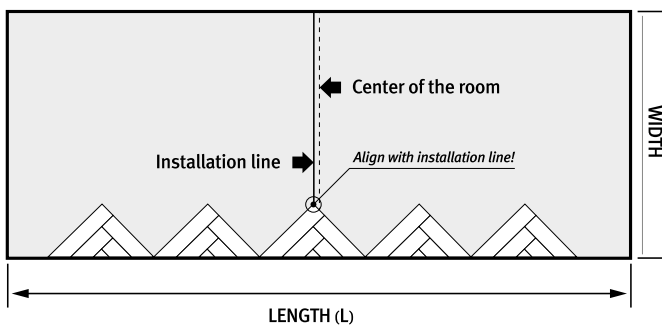

Lay out the triangles with their long side towards the starting wall.
Align the center triangle top with the installation line.

Make sure the underlay material is installed beforehand and the installation line remains visible.

Note! Use expansion wedges for the expansion gap.

5. Finalising the start row

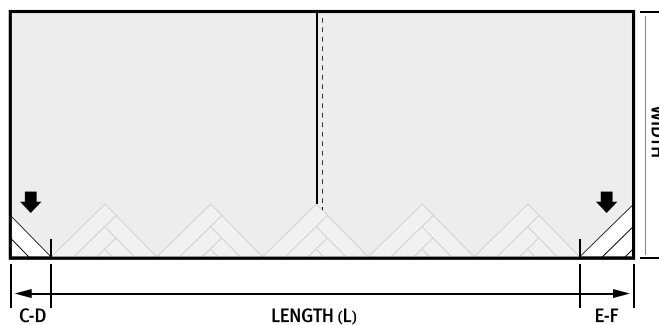

Now cut the distances C-D and E-F from the remaining triangle(s), and position them.

Note! In case you have calculated and built an uneven number of triangles, leave the outer two triangles aside. For the case that you have built an even number of triangles, lay one aside.

Further installation of pattern

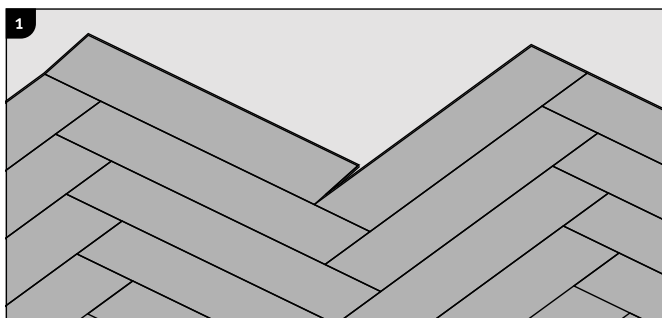

The boards need to be locked into one another, using the 5Gi system. To connect a new board you have to use a rubber hammer.

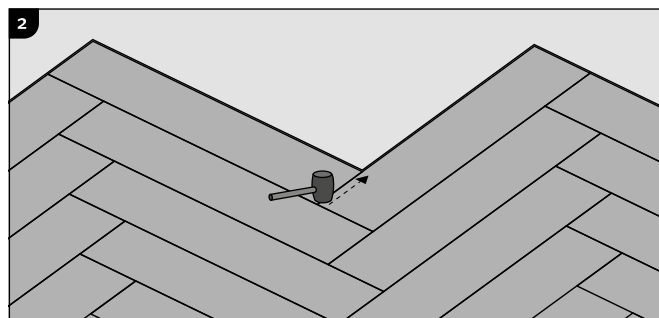

Use a rubber hammer and slightly knock at the 5Gi system to connect the short side. Start in the corner and work towards the end of the board.

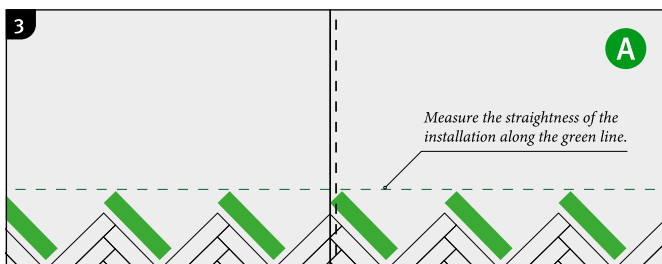

Install **A-strips** to connect all triangles. The joints between the A-strip and the triangle need to be checked very carefully. No protruding edge may be felt!

Cut the most left piece to fit into the room, considering an expansion gap. Measure the straightness of the installation along the green line. Repeat that measuring with the straightedge progressively throughout the installation. Deviations need to be corrected, should they occur (see schematics below).

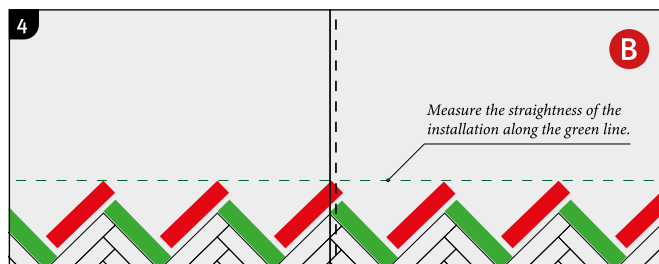

Now install **B-strips** and cut the most right piece to size.

Last row installation

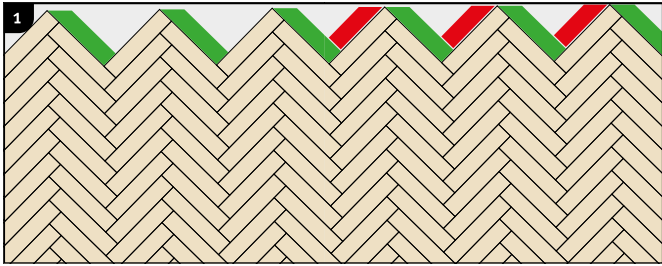

This alternating installation of A-strips and B-strips continues throughout the whole room. It is important to check frequently that:

- all expansion wedges remain in their position.
- all joints are closed and the strips are locked into one another.
- you follow the installation line.
- the tops of the strips in one line remain straight and perpendicular to the installation line

Note! Measure approx every fifth row.

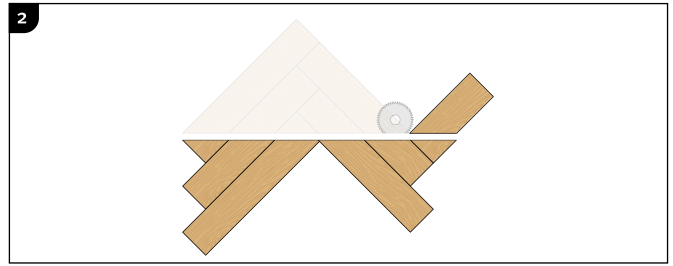

Excess pieces from starting triangles:

Dismantle the excess material from the starting triangles. Use it to close the open gaps to the finishing wall. Use the leftover from strips 1, 2 etc. consecutively and cut to size if necessary.

Installation around radiator/heating pipes

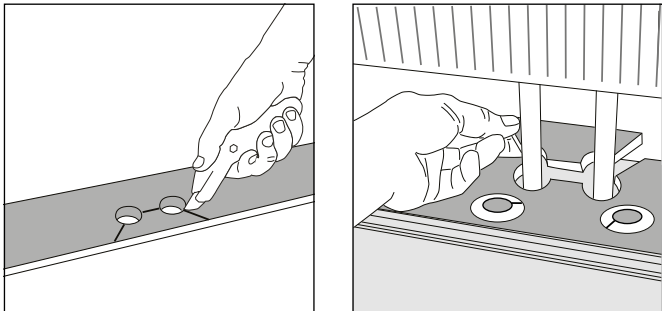

Drill holes two times larger than the diameter of the pipes. Remove a piece of the strip with a utility knife or a saw. Put the strip on one side of the pipes and the removed piece on the other side.

When angling is not possible

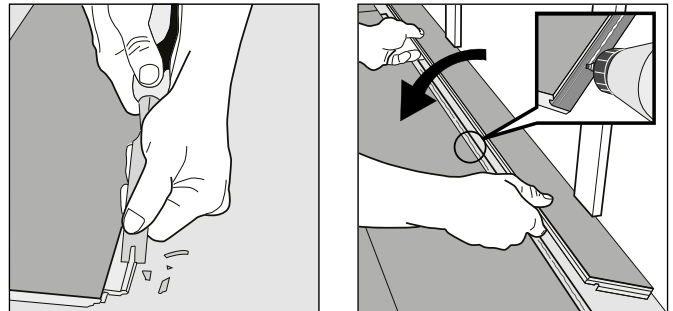

Remove the locking element according to the picture. Use an applicable glue to connect the strips. Press- place wedges between the glued strip and the wall.